

Enkadrain®

Guidelines for use
Gebrauchsanweisung
Mode d'emploi
Istruzione per l'uso
Mode de empleo
Gebruiksaanwijzing

Colbond bv
P.O. Box 9600
6800 TC Arnhem
The Netherlands

Telephone +31 26 366 4600
Telefax +31 26 366 5812

E-mail geosynthetics@colbond.com
Internet www.colbond.com
www.colbond-geosynthetics.com

ED-23-AL-A-06/2011

© Colbond bv
® Registered Trademark

The information set forth in this brochure reflects our best knowledge at the time of publication. The brochure is subject to change arising from new developments and findings; the same applies to our products. We undertake no liability for the results obtained by usage of our products and information.

COLBOND

Vertical use
Verticale Verwendug
Utilisation verticale

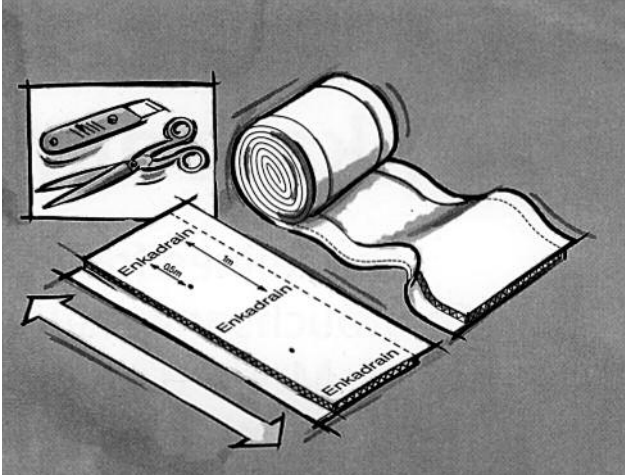

1 Cut to size
Maßgerecht zuschneiden
Couper à la longueur voulue

Installazione verticale
Instalación vertical
Vertikale toepassing

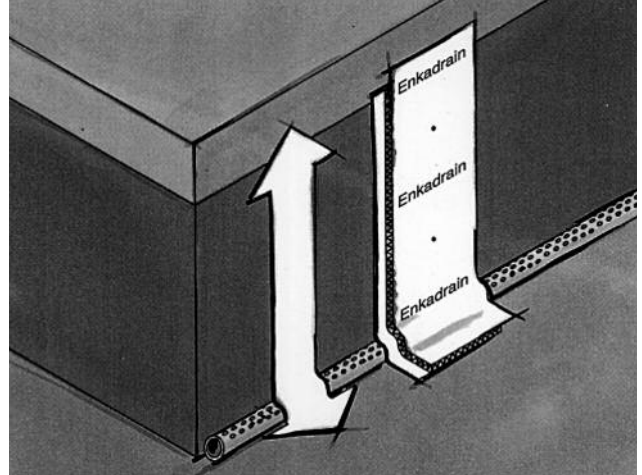

Taglio su misura
Cortar a la longitud deseada
Op maat afsnijden

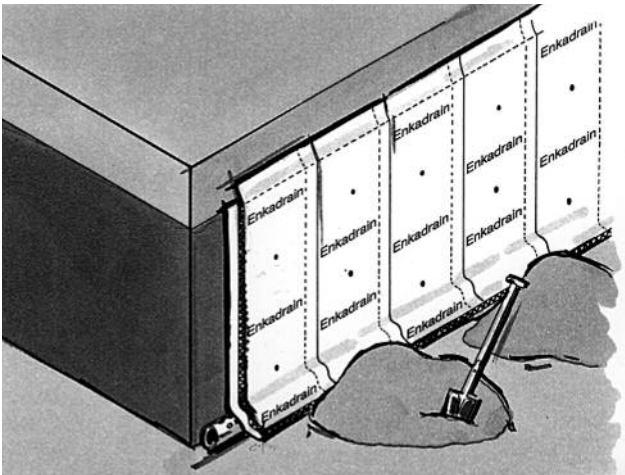

2 Laying direction
Einbaumöglichkeiten
Direction de pose

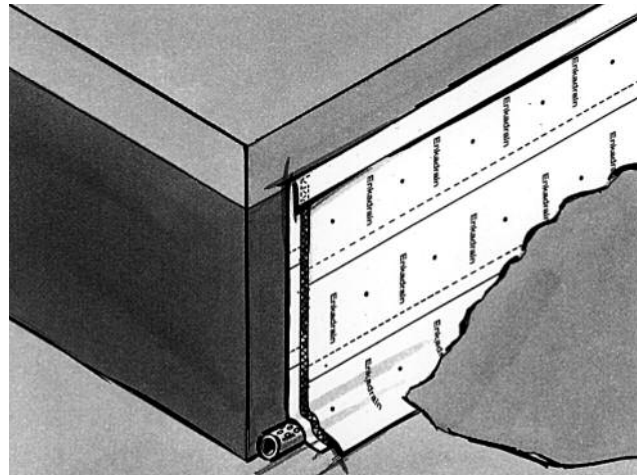

Direzioni di posa possibili
Forma de colocación
Inbouwrichting

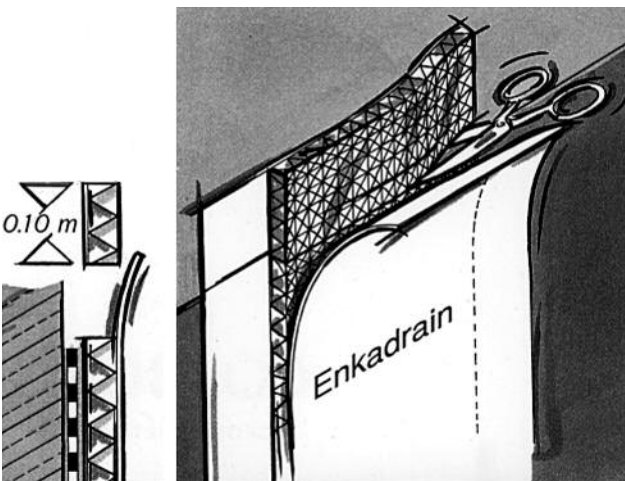

3 Fastening methods
Befestigungstechniken
Fixations possibles

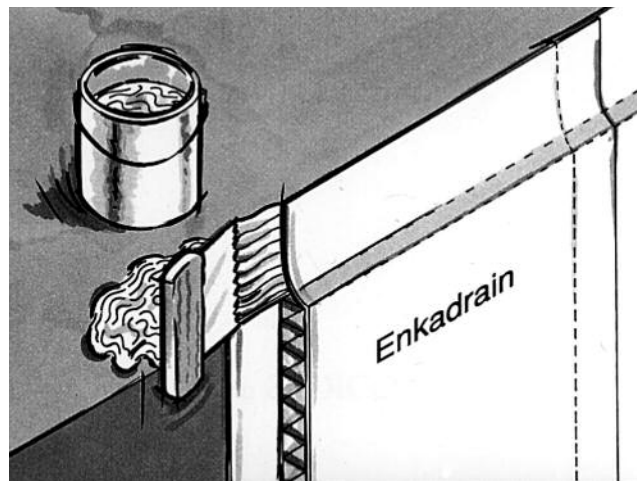

Metodi di fissaggio
Fijaciones posibles
Bevestigingsmogelijkheden

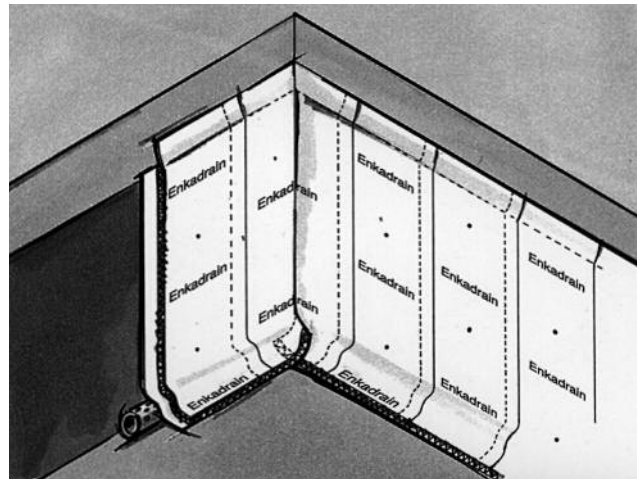
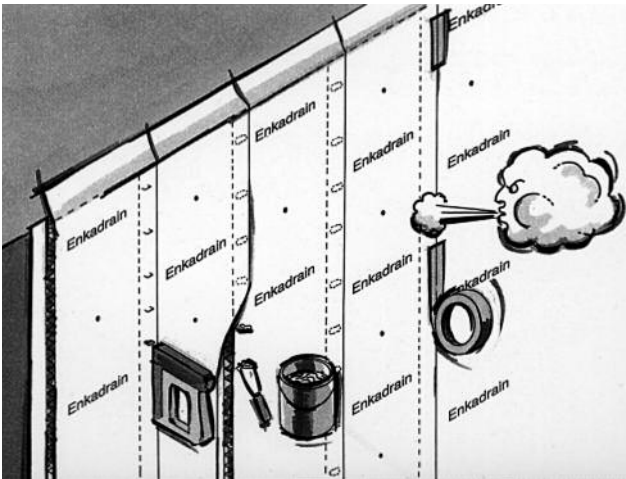
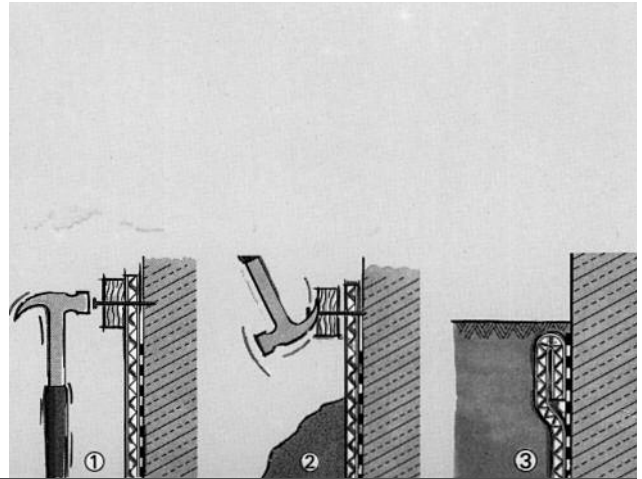
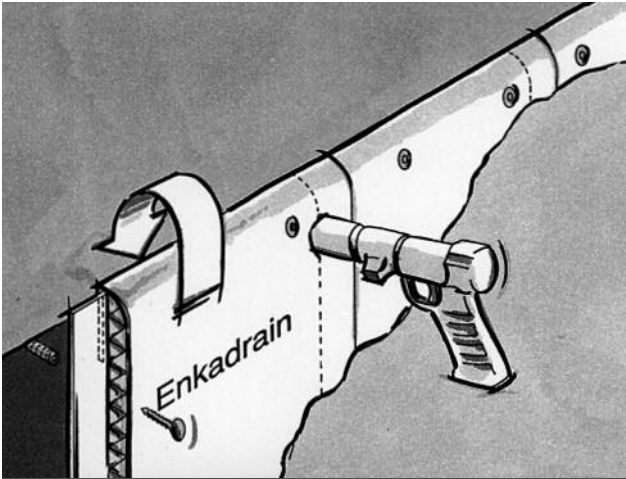

4

Finishing methods
Schlußarbeiten
Finitions possibles

Finiture
Acabados posibles
Afwerkingsmogelijkheden

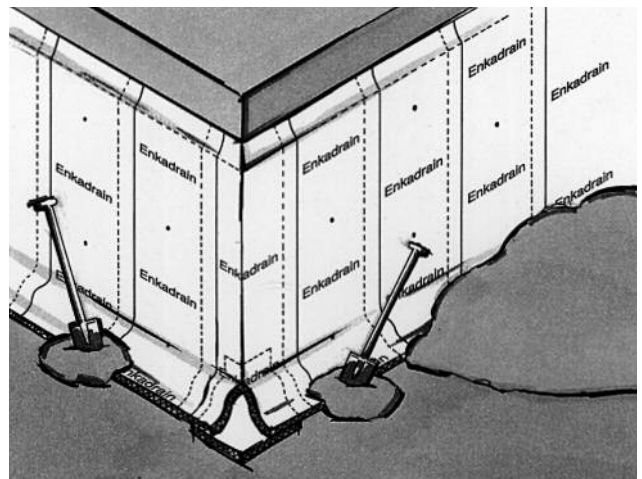
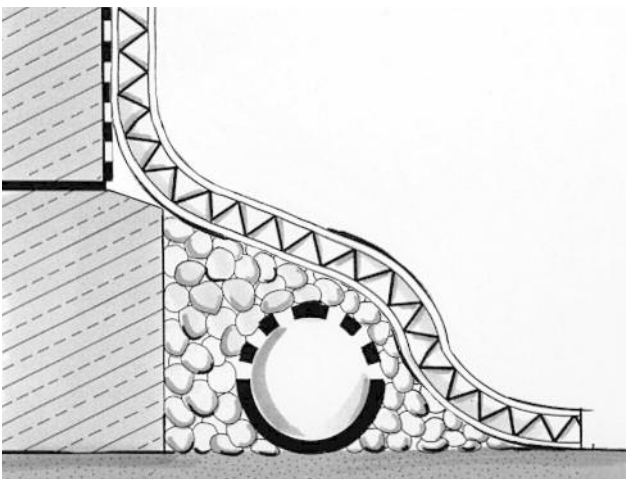

Horizontal use
 Horizontale Verwendug
 Utilisation horizontale

Installazione orrizontale
 Instalación horizontal
 Horizontale toepassing

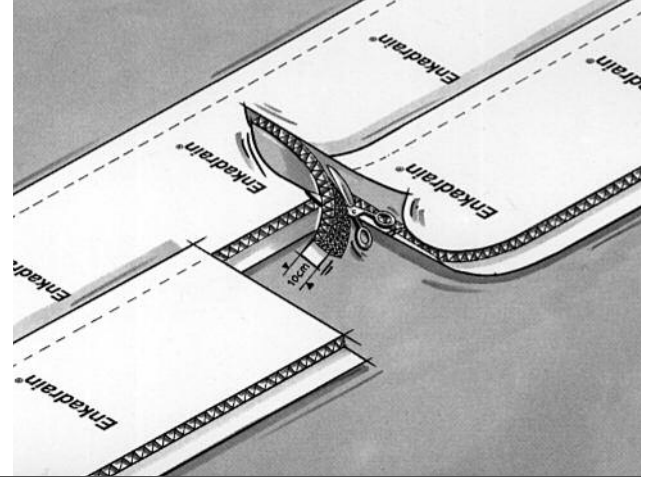
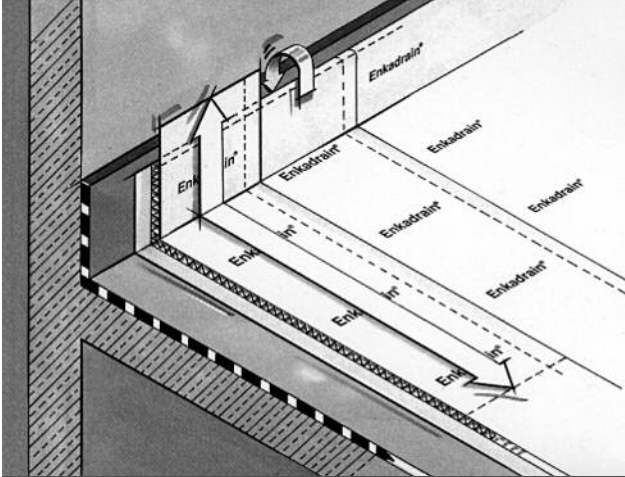

1 Cut to size
 Maßgerecht zuschneiden
 Couper à la longueur voulue

Taglio su misura
 Cortar a la longitud deseada
 Op maat afsnijden

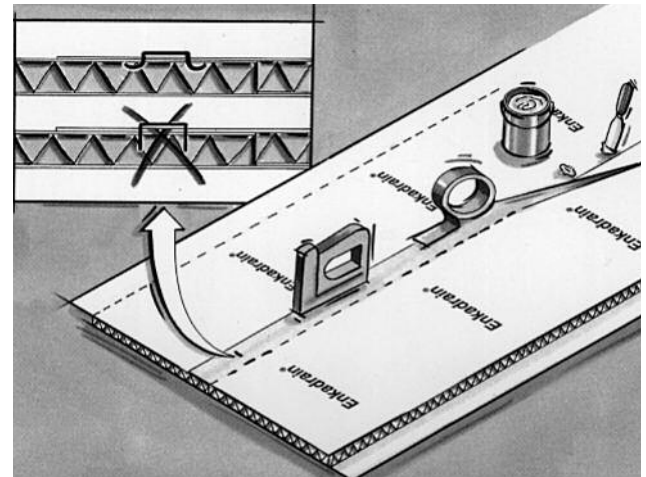
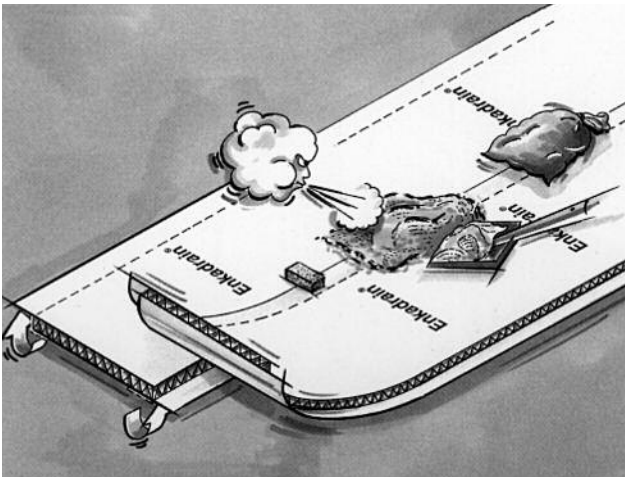

2 Fastening methods
 Befestigungstechniken
 Fixations possibles

Metodi di fissaggio
 Fijaciones posibles
 Bevestigingsmogelijkheden

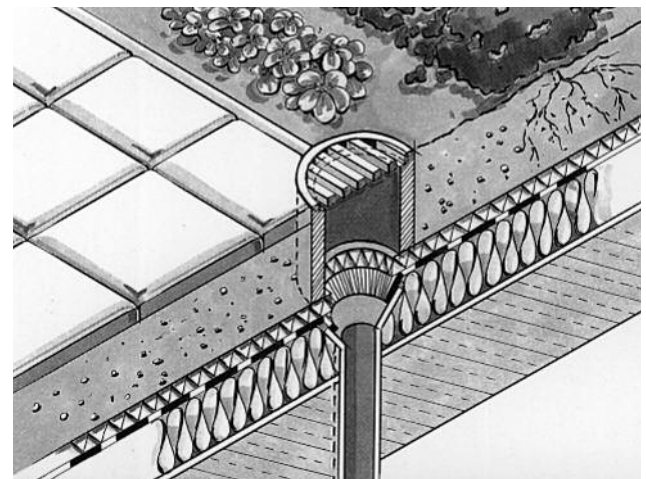
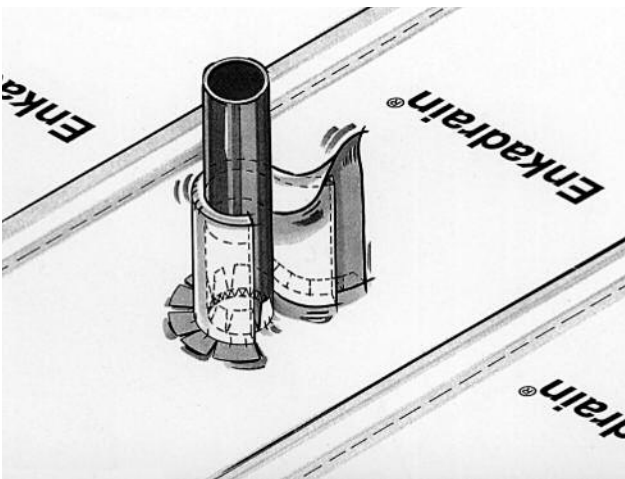

3 Vent and discharge point
 Durchführung und Ablauf
 Finition et évacuation

Con tubi di aerazione e scarico
 Punto de ventilacion y descarga
 Dakdoorvoer en hemelwaterafvoer